

Article number: 201242382A

Description: E+G Retaining magnets with threaded stud GN 52.4-ND-6-M3-E
Neodymium, iron, boron - 80° C, 6N

Measures

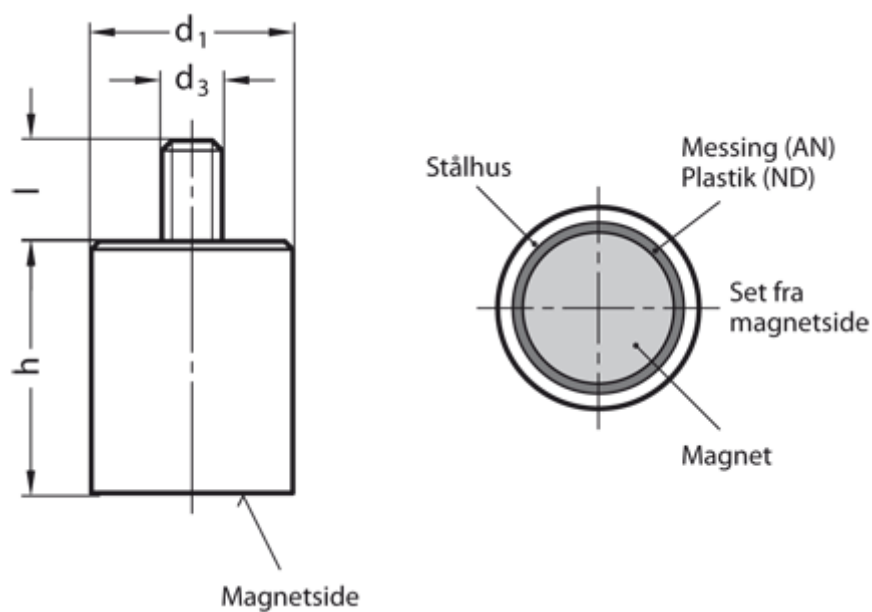

d1	= 6
d3	= M3
h	= 20 ±0,2
Holding force N	= 6.0
l	= 7
Material	= ND Neodym, iron, boron, 80°C